

Product Manual



ATSC-SDI 4

HDTV Tuner with HD-SDI

March 21, 2017

Version V2.25

HD Processor Version HD V3.31



4355 Excel Pkwy, Suite 600, Addison, TX, 75001
Phone: 972-931-2728 • Toll-Free: 888-972-2728 • Fax: 972-931-2765
E-Mail: Support@crwww.com • Website: www.crwww.com

Table of Contents

Overview	3
Installation	4
Quick Front-panel Setup.....	4
Setup Menus.....	5
Front-Panel Button Sequences.....	6
Firmware Update	7
Troubleshooting	8
HD2-RC IR Remote	9
Web Pages	10
On-Screen Menus	Error! Bookmark not defined.
Main Menu.....	Error! Bookmark not defined.
Channel Menus.....	Error! Bookmark not defined.
Caption Menus.....	Error! Bookmark not defined.
V-Chip Settings Menus.....	Error! Bookmark not defined.
Setup Menus.....	Error! Bookmark not defined.
Pop-Up Menus.....	Error! Bookmark not defined.
RS-232/Telnet/UDP Control Protocol	11
Control Commands.....	16
Terminal Communication Commands.....	18
HD2-RC Remote Emulation.....	18
Response Strings	19
Response Strings.....	19
RS-232 Cable Connections	20
Specifications	21
Physical.....	21
Front Panel.....	21
Back Panel.....	21
Tuning.....	22
Captioning.....	22
Includes.....	22
Options.....	22
Trademarks.....	22
Rack Mounting	23
RK2EZ Dual Rack Kit with Tie Bar Mounting.....	23
RK1 Single Unit Rack Mount.....	23
Limited Warranty and Disclaimer	23
Safety Instructions	24

Overview



The ATSC-SDI 4 is the first affordable HDTV Tuner that features an native HD-SDI port, and decodes MPEG-2 and MPEG-4 streams. A professional HDTV tuner, the ATSC-SDI 4 is controllable via RS-232, IP, and IR commands. An onboard Web page enables remote Web control. A new menu-driven display simplifies setup, and a front-panel USB port makes firmware updates a snap. The new compact enclosure allows mounting of two tuners in a single rack space.

The integral HD-SDI output allows inclusion of 708/608 captioning, choice of AES stereo or AC-3 audio, and scaled output set to a constant 1080i, 720p, or 480i resolution, or output at native resolution.

A universal TV tuner, the ATSC-SDI 4 can receive both analog and digital channels, in ATSC, NTSC, and clear QAM formats. Using an optional RF switcher, the tuner can switch between Antenna and Cable feeds.

- Tunes analog and digital channels in ATSC, NTSC, and clear QAM formats
- Decodes MPEG-2 and MPEG-4 transport streams
- SDI port outputs the tuned program, with captioning and V-Chip data, resolution scaled to 1080p, 1080i, 720p, 480i, or Auto (native resolution)
- Component, and composite video ports, as well as stereo, SPDIF coax and optical audio ports
- Consumer or Pro settings for digital audio
- Dolby® 5.1 or PCM/Variable PCM digital audio formats for digital audio ports
- HD-SDI selectable to pass through Dolby 5.1 as AC-3 or decode to stereo AES audio
- Front-panel text and onscreen menus for tuner setup
- Web page for remote setup and control
- Supports dual Air/Cable tuning with optional RF-AB switch
- 608 (SD-SDI) and 708 (HD-SDI) closed captioning embedded in SDI output
- Internal scaler displays all channels at selected resolution
- Rack-mountable in 1RU, two across
- Full ASCII 2-way RS-232/Telnet commands; AMX, Crestron, and RTI modules available; IR and wired IR commands include discrete power commands
- RS-232 can be daisy-chained to control up to 9 tuners from a single RS-232 port, or control any number of tuners via IP
- Field updatable for control and HD processing firmware via USB
- Meets RoHS and California energy-saving standards
- Includes HD2-RC IR remote and 12 VDC power supply
- Options for single and dual rack mounts, stereo mixer/amplifier, external RF-AB RF switch
- Free option to drive up to 4 tuners from a 12 VDC 8A power supply, ask when ordering.

Installation

There are 3 ways you can change the settings:

- **Front Panel.** Press the SETUP button use the Up/Down buttons to move through menus, Left/Right to change settings, then press SELECT to store the changes at each step.
 - Press SETUP to access the front-panel menus
 - Use the Up and Down arrows to step through each menu
 - Use the Left and Right arrows to choose an option
 - Click Select to save the change for each menu
- **IR.** Use the included IR remote to turn on/off, scan for channels and access on-screen menus. All the IR functions can be accessed from the front-panel buttons
- **Ethernet.** Access the onboard Web pages. Helpful for remote access when system is fully integrated with site Ethernet. V2.24 – Hold SETUP to see IP address.

The front panel LCD shows the current channel and name, if the HD analog output is set to RGBHV or YPbPr, resolution of the channel, and if it's on Air or Cable.

Quick Front-panel Setup

RGB or Component out	Click the SETUP button, use Up or Down to HD Output menu, use Left or Right keys to choose input, press SELECT to choose. HDMI is always active.
HD Resolution	Go to the next menu down, and cycle through the list of resolutions. Press SELECT to choose. Note that our Component port supports 1080p – we've found a number of TVs that support that resolution.
Air or Cable Tuning	Go to the next menu and select CATV, Air, IRC, HRC, or CATV Auto. Press SELECT to choose. IRC has the same channel map as standard CATV, except for 5 and 6. The HRC channel map uses completely different frequencies than the others. CABLE AUTO looks at the first few channels to determine the right format. If there are no channels between 2 and 6, you may have to set the tuning mode manually.
Select Scan Mode	<p>Page down a number of menus to the Scan Mode menu. The Left or Right keys will select several options</p> <p>Analog+Digital (standard full scan) Digital – Delete Analog (scan for digital, delete any analog channels) Digital – Keep Analog (scan for digital, but keep all analog channels) Analog – Delete Digital (scan for analog, delete any digital channels) Analog – Keep Digital (scan for analog, but keep all digital channels)</p> <p>Once you do the next step, scan from the front-panel menu, the tuner will always scan this way from the panel or on-screen menu – until you change the mode later on.</p>
Channel Scan	The next menu starts the Channel Scan , just press SELECT to start scanning. You can watch the scan progress from a pop-up window on the video outputs from the tuner. You can watch the scan process if the output of the tuner is fed to a display. A Cable analog/digital scan will take 7 minutes, only digital 6 minutes (the analog scan is faster).
	The Blue MENU button enables IR on-screen menu control using the Arrow and SELECT buttons, primarily for scanning channels and other on-screen functions.

Front Panel Setup

Setup Menus

Press **Setup** to enter menus. Use **Up** and **Down** buttons to page through options, **Left** and **Right** buttons to change settings. Press **Select** to enter the setting.

Menus	Options
Firmware	232-ATSC+1 V5.0 To update the firmware, click Power and Setup while on this menu while connected via USB. That will open up a file folder. Copy the file to the tuner memory, the tuner installs the update itself. Press Left to return to normal operation. Also, when this menu is displayed, you can click the Right key to view Bootloader version, HD version, and DC voltage.
HD Resolution	1080i (Default) 720p 480i 1080p Auto
Tune Mode	CATV (Default) - Switches tuner to Cable, sets Scan mode (See mode 6) Off-Air - Switches tuner to Air, sets for Off-Air channel scan IRC - Switches tuner to Cable, sets Scan mode HRC - Switches tuner to Cable, sets Scan mode Cable Auto - Switches tuner to Cable, sets Scan mode
Digital Audio	AC-3– Dolby 5.1 (SDI audio will be AC-3) PCM (SDI audio will be AES stereo, Group 1) PCM Variable (Default)
Refresh Rate	1080p is fixed at 60Hz 1080i and 720p can be set to 60 or 59.94 Hz
Baud Rate	300 600 1200 2400 4800 9600 (default) 19200
Unit Number	1-9, default is 1
Panel Lockout	None, Ch+Menu, Vol+Menu, Ch+Vol+Menu, Power, Setup, Menu, All, Setup+Menu, Pwr+Setup+Menu
Backlight	Display brightness 1-10
LCD Contrast	Contrast 1-9
IR Receive	IR On, IR Off
Captions	On, Off (default)
Caption Mode	CC1, CC2, CC3, CC4 Text 1, Text1, Text3, Text4 (Text options rarely used)
Digital Captions	Service 1-6, Default is 1
Scan Mode	Sets how the tuner will scan the channels Analog+Digital (standard full scan) Digital – Delete Analog (scan for digital, delete any analog channels) Digital – Keep Analog (scan for digital, but keep all analog channels) Analog – Delete Digital (scan for analog, delete any digital channels) Analog – Keep Digital (scan for analog, but keep all digital channels)
Channel Scan	Press Select Starts the scan, follows the Tune Mode selection Starts with analog channels, then digital. You can press Select to skip analog.
Overscan	Selects % overscan for all channels 0-9

Menus	IP Configuration
	Typical operation: <ul style="list-style-type: none"> • Press Setup to edit value, characters will flash • Use directional keys to change • Press Setup to save
IP Port	23 IP port for Telnet communication – Click or hold Up or Down to set.
IP Address	192.168.1.231 Left/Right steps through each group, click Up or Down to step one at a time, hold down to move faster.
IP Gateway	255.255.255.000 Quad address – Left/Right steps through each group, click Up or Down to step one at a time, hold down to move faster.
Subnet Mask	255.255.255.0 Subnet has a limited range of combinations, so this function is simplified Left/Right steps through each group, click Up or Down for options
IP Mode	Selects Static (default) or DHCP IP modes <ul style="list-style-type: none"> • DHCP will select new address • IP Address will show change when you select DHCP • If you go back to Static, the address you defined in that mode will be set
MAC/SN	Shows network MAC address Ex: 00:14:C8:03:13:BF First 3 bytes is the CR MAC address, 02 designates ATSC-SDI 4, and the last two are the serial #.
Menus	General
UDP Reply	Sets UDP Reply on or off
Clear	Clears network password (set Web page password from Settings page)
HDMI Audio	Turns HDMI (SDI) audio on or off (On is default)
Digital Audio	Consumer(default) or Pro for digital audio

Front-Panel Button Sequences

- Pressing **Up** and **Down** keys toggles air/cable tuning
- Pressing **Left** and **Right** keys toggles mute on/off
- While on **Setup: Firmware**, and when a USB cable is connected to a PC, clicking **Setup** and **Power** will start a firmware upload process, and a file window will open up on the PC desktop.
- After the firmware installs, pressing the **Left** key will exit the firmware mode
- If the **Setup** key is locked out, pressing **Setup** and the **Right** key will unlock setup until the tuner resets, and turn the tuner on if it is off (even if the Power button is locked)
- Press **Power** and **Up** together when at **Setup:Firmware** menu to reset to default settings

Firmware Update

- On the tuner, select **Setup/Firmware** to view current S37 and HD Load firmware – click the Right arrow twice to view the HD Load version
- Download the Firmware Pack file from the ATSC-SDI 4 Product page
 - Browse to www.crwww.com
 - Select **Products**, then choose the ATSC-SDI 4
 - Select the **Downloads** tab and download the latest firmware pack
 - Extract the ZIP folder, usually on your Desktop or in the Downloads folder
- Install the S37 firmware first, then update HD Load

System Firmware over Front-Panel USB

The system firmware (S37) is a simple, fast update. It's a small file and doesn't take too long to update.



Connect USB cable as shown above

In the 232-ATSC 4/ATSC-SDI 4, you won't need an RS-232 port. Just copy or drag the S37 Update file to a pop-up file window, just as if the tuner was a memory stick.

- Connect your PC to the front panel USB port of the ATSC-SDI 4.
- Copy the S37 file in the Firmware Pack folder
- Select the red **Setup** button on the ATSC front panel, then go to the **Setup: Firmware** setting
- Click **Setup** and **Power** together – a file folder will open on your desktop and the front panel of the tuner will display **Firmware Loader**. Some PCs are set to not automatically open the folder – you may need to look for the folder in Windows Explorer.
- Paste or drag the S37 file into the folder
- The front panel will show **File Loading**, then **Copying Image**.
- When the process is complete, the display will change to **Firmware Loader**
- Press the **Left** to exit the mode, no need to exit **Setup** or reset power

USB Memory Stick for HD Firmware



- Copy the file HD4_V3xx.rom or HD4SDIV3.xx to the root of a memory stick. Make sure that it is the only *.rom file on the stick.
- Memory formatted as FAT, FAT16, or FAT32, not NTFS
- Place USB memory stick in the back USB port of the ATSC-SDI 4
- Power on tuner.
- Press Setup, and then select the **Firmware** menu. Press the right arrow twice to display the current **HD Version**. Press both **SETUP** and **POWER** buttons at the same time. The update takes about one minute.

Troubleshooting

TUNING CABLE CHANNELS

Tip: The 232-ATSC-SDI 4 will skip encrypted channels automatically when you activate a channel scan

Tip: You can skip scanning analog channels by pressing **Select** after you start the scan.

Symptom: Channel ID is in XX-XX form, not cable box Guide form

- Cable boxes translate the actual channel #s into a virtual Channel Guide, using channels 2 – 900, or more.
- The actual (physical) channels have IDs in XXX-XX form, just like off-air channels. Non-cable HDTV tuners like the ATSC or LCD TVs don't provide Guide features, so the channels will be displayed in their native, physical major-minor channel form.
- Some cable companies are using a useful format – the cable channels will have a single virtual channel that is the same as the Guide, and local TV channels may use the same virtual major-minor listing as the off-air channel.
- Some cable franchisees have a listing by physical channel, many do not. You can press the INFO button on the HD2-RC remote to view the channel name.

POWER/ NO VIDEO or AUDIO

Symptom: Tuner cycles power and LEDs

Power supply is not providing enough amps of power (1 A or more). If you're replacing an old CR analog tuner, the old power supply is 500 mA, and will cause the "power cycle" effect. Use the power supply that came with the tuner, or call to order a new one. Voltage range should be 11-14 VDC.

Symptom: Tuner appears to be on, channel display is lit, but unresponsive, no video/audio out

- When the tuner turns on, it will display **Voltage Low** or **Voltage High** if there is power problem.
- Go to the **Setup: Firmware** menu and click the **Right** key to display the exact voltage.

Symptom: Tuner stays locked at Power On text

Reload the latest S37 firmware (see **Alternate Update** note at the end of the **System Firmware** section on page 9).

IR Control

Symptom: IR remote won't control tuner

Hold down IR remote **Select**, press **9**, and release both. Front-panel setting should be **IR On**. In addition, check if the remote works when the lights are off. Some energy-saving fluorescent lights produce interference at our IR frequency (57 Hz). Try to cover the IR sensor so the lights don't affect operation, or add the IR-RXC External IR Sensor. It's easier to hide and tilt the sensor to help with reception, and you can try **Select** and **4** to use the lower IR frequency (the RXC has both types of sensors).

Captioning on Video Outputs

Symptom: Video out does not include captioning data

The 232-ATSC-SDI 4 provides on-screen captioning on all ports, the SDI port supports 608/708 captioning, and the Composite video includes Line 21 data. The Component port does not output captioning data, not supported in the Component standard.

HD2-RC IR Remote

The HD2-RC IR Remote included with the 232-ATSC-SDI 4 can be used to setup the tuner and for daily operation. All of the functions on the remote have equivalent commands in RS-232, Ethernet, and Wired IR formats. In addition, the 232-ATSC+ front panel buttons can perform Power, Channel, and Volume control.

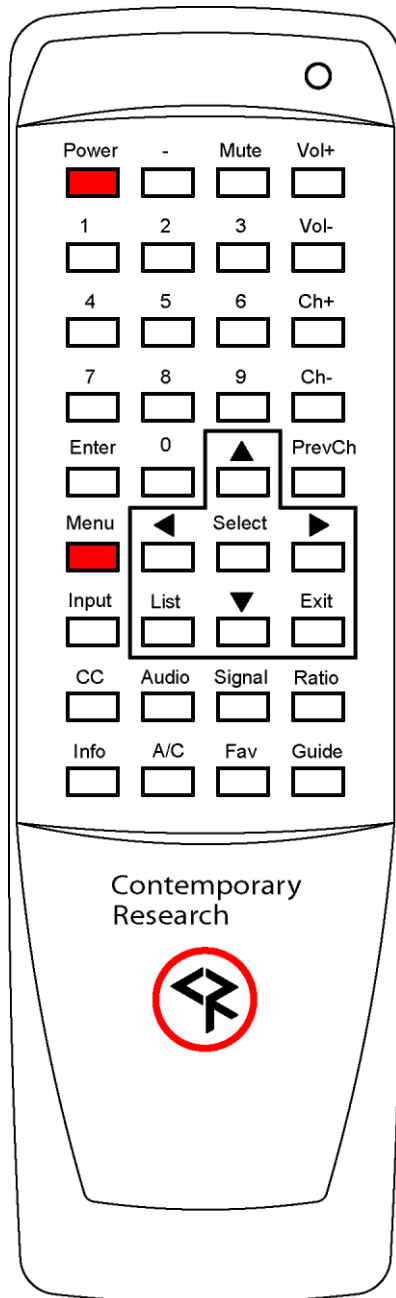

Power

Turns tuner on and off. Discrete on and off IR commands are available as well.

Volume Control

Use the **Vol+**, **Vol-** and **Mute** buttons.

Channel Selection

The key change in digital tuning is the need to add a dash (-) and number after the traditional channel number. Analog channels are accessed using XX-0, digital channels using XX-1 (or -2, -3, etc).

Ch+, **Ch-** and **PrevCh** can be used to access and recall channels.

Menu Operation

Press Menu to access the on-screen menus.

- Use the directional **Arrows**, **Select** and **Exit** to navigate the menus.
- **List** displays the list of all channels, arrow keys add/remove channels, set Favorite Channel list
- **Exit** steps backwards out of menus
- **Enter** selects menu choice

Special Functions

- **CC** steps through available closed-captioning options
- **Audio** selects audio and SAP modes
- **Signal** displays channel signal level
- **Ratio** steps through aspect ratios, options depend on channel and output types
- **Info** launches on-screen information window
- **A/C** selects Air or Cable tuning
- **Fav** Displays list of favorite channels
- **Guide** displays on-screen Guide

Features of many of the Special Function commands depend on whether the current channel is analog or digital.

Tip: The output rules behave differently for digital and analog channels. When you set up the tuner, use the **RATIO** button to set image output for a digital channel, then tune to an analog channel and set that to 16:9 or 4:3. The same rule applies to the Menu/Setup/Screen Format menus. Set for analog and digital.

Web Pages





Control Page





Settings Page





The 232-ATSC-SDI 4 features Web pages accessible by any browser over IP. The Control page features a full array of control options with interactive status feedback, including the native resolution of the program and if no signal is present. The Settings page can change all aspects of tuner setup and operation. The name of the tuner can be changed by clicking on the name at the top of the page.



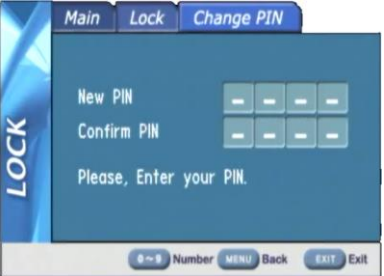

The Password can be entered from the Settings page. To change the password, one would need to know the previous password, or clear the password from a front-panel menu.

On-Screen Menus

<p>Main Menu</p> 	<p>Selects sub-menus.</p> <ul style="list-style-type: none"> • Arrow keys highlight option • Select (or Enter) chooses option • Menu steps back or exits menu • Exit exits all menus • Some options are only available if you are currently tuned to an analog or digital channel
<p>Channel Menus</p> 	<p>Sub-Menu for Channels offers options for:</p> <ul style="list-style-type: none"> • Channel Auto-Scan • Favorite Channel Selection • Add/Delete Channels • Fine Tune (If tuned to an analog channel) • Signal Strength Meter
<p>Auto-Scan</p> 	<p>Starts scan of analog and digital channels for:</p> <ul style="list-style-type: none"> • Air – looks for NTSC and ATSC channels • Cable Auto – looks for analog and digital QAM cable channels, as well as all frequency plans • Cable STD - standard cable spacing • Cable HRC – HRC cable spacing • Cable IRC – IRC cable spacing <p>Tip: Normally, use Auto. Most cable channels will be in standard frequencies. If all the channels tune in STD but channels 5 and 6, scan for IRC. If few channels can be found, scan for HRC.</p>
<p>Favorite Channels</p> 	<p>Menu is also displayed from the List command, selects channels advanced by the FAV favorite channel command.</p> <p>Use the Up, Down arrows to move through the list, press Select to add a channel to Favorites.</p>

<p>Channel Add/Delete</p> 	<p>This menu can add or delete a channel accessed from Channel Up and Down.</p> <p>You can tune to a channel you want to delete, then press Menu/Channel/Add-Delete. Press Select to delete the channel. You can also keep the page on screen as you step through channels, adding and deleting as desired. If the channel has a good signal, it will be displayed in the background.</p> <p>Note that HDTV channels are broadcast on UHF frequencies. The Add/Delete will show the name of the digital channel, as well as the actual UHF channel used for broadcasting.</p> <p>You can delete one of a digital channel's sub-channels without affecting the others.</p>
<p>Signal Strength</p> 	<p>This page also displays from the Signal remote command. The graphic shows the current signal strength, and changes in real time. This allows you to monitor the strength of a channel as you adjust the antenna for best reception.</p>
<p>Caption Menus</p>	
<p>CAPTION</p> 	<p>This menu accesses captioning features:</p> <ul style="list-style-type: none"> • On/Off – turn captions on/off – <i>other options are not available if captions are off.</i> • Analog Mode - CC 1-4 and Text 1-4 • Digital Mode – Service 1-6 • Digital Font Options <ul style="list-style-type: none"> • Size – Standard (15 pixels), Large (21 pixels), or Small (11 pixels) • Style – 1-6 • Color – 8 shade of background, foreground and edge colors • Opacity – foreground and background • Edge – 6 style options <p>Version displays current version of tuner firmware</p>
<p>V-Chip Settings Menus</p>	
<p>LOCK</p> 	<p>Manages access to programming for US and Canadian standards.</p> <p>The default PIN number for access is 0000 (four zeros).</p>

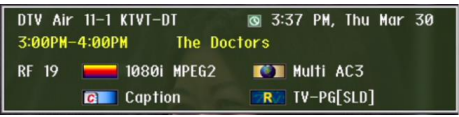
<p>Change PIN</p> 	<p>Enter and confirm new PIN for access.</p>
<p>US Rating</p> 	<p>Use arrows and Select functions to select level of Movie and TV rating allowed.</p>
<p>Canada Rating</p> 	<p>Use arrows and Select functions to select level of Movie and TV rating allowed.</p>
<p>Setup Menus</p>	
<p>Setup</p> 	<p>This series of menus select the options for tuner operation:</p> <ul style="list-style-type: none"> • Screen Format – 16:9 or 4:3 NOTE: Set when tuned to a digital channel, again when tuned to an analog channel – these are two different settings! You can use RATIO on the remote – does the same setting. • Time • Sound Settings • Video Noise Reduction - On/Off (if tuned to analog) Set to On – helps to clean up analog channels • Menu Language – English, Spanish, French
<p>Screen Format</p> 	<p>Selects between 4:3 and 16:9 aspect ratios. The Ratio command can also adjust the settings.</p> <ul style="list-style-type: none"> • 4:3 Display offers three options for 16:9 video: 16:9, 4:3 (stretched vertically), and Zoom (cropped sides) • 16:9 Display offers three options for 4:3 video: 4:3 (small centered), 16:9 (stretched horizontally), and Zoom (stretched vertically and horizontally) – or 4:3 and 16:9 if the video is 16:9

<p>Time</p> 	<p>Sets time settings for:</p> <ul style="list-style-type: none"> • Daylight Saving – Select and choose on or off Note – The DST trigger comes from the broadcast stations, and may not be in sync with the new US standards. Use On/Off or time zone to offset time • Time Zone – Select local time Zone
<p>Time Zone</p> 	<p>Use left-right cursors to select the time zone, Select enters the current zone.</p>
<p>Sound</p> 	<p>Selects a variety of options, each is only active when you are currently tuned into an analog or digital channel:</p> <ul style="list-style-type: none"> • Analog MTS – Mono, Stereo, SAP (same as Audio) • Multi-Track – English, French, Spanish • Digital Out – AC-3 (Dolby 5.1), PCM, or variable-level PCM. Set to PCM when using audio through the HDMI connection – most displays cannot decode AC-3 (Dolby 5.1). • Auto Volume – On or off
<p>Info</p> 	<p>New Info pop-up (HD3.31) adds more data on stream format (MPEG2-MPEG4), and physical channel ID.</p>
<p>Guide</p> 	<p>Shows a list of current channels</p>

RS-232/Telnet/UDP Control Protocol

Overview

The 232-ATSC-SDI 4 full duplex RS-232/Telnet protocol enables a system programmer to control all TV Tuner functions as well as monitor TV Tuner status. All commands are sent as ASCII strings. No delays between characters or commands are required, as data is interrupt driven and buffered.

The 3 status groups are: Channel/Source Select, Audio Levels/Mode and Front Panel. The Power button-function status from the 232-ATSC+ front panel has been grouped with the Channel/Source for simplicity in the most common modes of operation. Each of the groups has one ASCII status response string containing all of the status data for that group. The current status string of a group is sent from the 232-ATSC+ whenever a valid command for that group is received by the 232-ATSC+ RS-232 port or front panel. A group's status may be requested at any time via the RS-232 port. Status of all 3 groups is sent at power up. The format of each group's status response string remains the same always.

Up to 9 232-ATSC-SDI 4 units may be cabled together and addressed for individual control from a single RS-232 port. Each 232-ATSC-SDI 4 is assigned a unique unit code.

Communications parameters (Front Panel Mode 1) are 300 to 19200 baud, 8 data bits, No parity, and 1 stop bit. Factory default is 9600 baud, Unit#1. All settings are saved to NVRAM in the 3 ATSC-SDI 4.

The tuner will accept non-standard RS-232 control such as voltage that swings from 0 to +5 VDC, commonly found when IR ports are used to send RS-232 commands.

The same commands can be sent over IP Telnet (up to two sessions) and via UDP to the tuner's IP to port 31931 (fixed) with status feedback on port 31932. Port 31932 is disabled by default, send ">UO" command (UF turns UDP status feedback off) or set with front-panel menu. See our Support Blog [How to Test 232-ATSC 4/ATSC+1 UDP Control](#) to learn more about UDP control.

General protocol specifications

Characters in command strings to the 232-ATSC+ are common ASCII keyboard characters.

Command strings sent to the 232-ATSC+ begin with the ASCII > (greater than symbol) as an 'Attention' character and end with carriage return - ASCII CR, Hex \$0D, or keyboard Enter - as an 'End-of-command' character.

Responses from the 232-ATSC+ begin with the ASCII < (less than symbol) as an 'Attention' character and end with a carriage return followed by line feed an ASCII LF or Hex \$0A as 'End-of-command' characters.

A carriage return is required at the end of each command and is assumed in all examples.

Command String Structure

[Attention] (Unit#) [Command] (Parameters) [Return]

Attention	Single character (>) starts the string
Unit#	The Unit# is expressed as an ASCII 0-9 when used in multiple tuner applications. To address all units, use a Unit # of 0 (Zero) No unit number will default to Unit#1
Command	A two-character command
Parameters	Added attributes to some commands
Return	A carriage return ends the command string, you may use ASCII CR, Hex \$0D, or keyboard 'Enter' in programming. For simplicity, the programming examples in the manual will not show the 'CR' – so remember, you'll need to add it in your control code.

Command and Status Response

Commands can be sent back to back at any time without any delay. To allow for rapid, multiple commands, status responses are intentionally delayed by about 125mS, sending the most current status in response to control commands or user actions.

Control Commands

Code	Function	Operation
	Front Panel	
S4=	Set front panel lockout mode	0 =None 6 = Menu 1 = Ch+Menu 7 = All 2 = Vol+Menu 8 = Setup+Menu 3 = Ch+Vol+Menu 9 = Pwr+Setup+Menu 4 = Power 5 = Setup – Press Select and Right to unlock temporarily
Q5=	Set IR Receive mode	0 - No IR reception 9 - CR 9 (Default)
KK=105	Menu	Opens on-screen menus
KK=106	Right	Left
KK=107	Left	Down
KK=108	Up	Up
KK=109	Down	Down
KK=110	Enter	Enter
KK=111	Exit	Exits menus
KK=95	List	Displays on-screen list to select favorite channels
P1	Power On	On
P0	Power Off	Standby, mutes audio and video
PT	Power Off/On	Power toggle
	Tuning	
TC=	Select tuned channel	Tunes analog and digital channels, leading zeros OK, up to 4 characters for analog or single-unit digital channel, 3 characters for major and minor channels. <i>Examples:</i> '>TC=28:1' Selects channel 28-1 '>TC=28-2' Selects channel 28-2 '>TC=32' Selects 32-1, 32-0 if no digital '>TC=32-0' Selects analog channel
TU	Tune channel up <i>Example:</i> '>3TU'	Selects next higher channel in channel list Bumps Unit#3 tuned channel up
TD	Tune channel down	Selects next lower channel in channel list
TP	Previous channel	Selects previously viewed channel
T^	Start Channel Scan	Initiates new channel scan for analog and digital channels, scan operation set by D0 and S0.
S0=	Tuning Format	0=CATV (Default) - Switches to Cable, sets scan mode 1=Off-Air - Switches tuner to Air RF input and channels 2=IRC - Switches to Cable, sets scan mode 3=HRC - Switches to Cable, sets scan mode 4=Cable Auto - Switches to Cable, sets scan mode
D0=	Set Channel Scan Mode	Sets scan mode for digital and analog channels from the T^ or front panel scan command. 0= Scans for analog and digital channels scan (default) 1= Scans for digital only, deletes analog channels 2= Scans for digital only, keeps analog channels 3= Scans for analog only, deletes digital channels 4= Scans for analog only, keeps digital channels A scan must be triggered by T^ or front panel before the onscreen Menus will scan following D0 rules.
XD=	Channel delete	XD=<major>,<minor> removes channel from channel list. <i>Example:</i> '>XD=0,0' removes current channel
XA=	Channel add	XA=<major>,<minor>,<physical> adds channel <i>Example:</i> '>XA=38,1,0' Physical channel will be same as major
NC=	Channel name status	>NC returns channel name
NP=	Program name status	>NP returns program name
DH=	HDMI Audio Mute	Turns SDI audio on or off 1=Audio mute on 0=Audio mute off (default)

Code	Function	Operation
KK=151	YPbPr Out	Fixed at Component (YPbPr) output and colorspace
D4=	Overscan (0-9)%	Removes upper scan lines that may appear in output, usually from an analog channel, affects all outputs, 0% is default. <i>Example:</i> '>D4=3' Overscan by 3% (typical solution)
KK=82	Ratio	Steps through aspect ratios, options depend on channel and output types
KK=81	Signal	Displays signal Strength
KK=100	Info	Launches on-screen information window
KK=63	Guide	Displays Electronic Program Guide
KK=115	CC – Closed captions	Steps through captioning options
Q0=	Caption Mode Off (0-2) <i>Example:</i> '>Q0=0' or '>Q00'	Sets captioning mode 0=Captioning off (default) 1=Captioning on Captioning off
Q1=	Analog Captioning Type (1-8)	Turns on captioning type 1=Caption 1 4=Caption 4 2=Caption 2 5-8= Text 1-4 (rarely used) 3=Caption 3
Q7=	Digital Caption Service	Set to 1-6 (1 is default)
	Audio	
VU	Ramp volume up	Starts volume ramping up
VD	Ramp volume down	Starts volume ramping down
VH	Sets volume level 0-100	Volume level, scaled in 100 steps
VL	Sets volume level 0-63	Volume level, scaled in 63 steps, as other 232 tuners
VX	Volume Mute off	Restores audio volume to previous level
VM	Volume Mute on <i>Example:</i> '>VM'	Turns off audio outputs Mutes audio outputs
VV	Stop volume ramp	Stops volume ramping
VT	Toggle Volume Mute	Alternates audio mute on and off
DL=	Set Power-Up volume	0-63
KK=85	Audio Mode	Step through audio mode options for mono, stereo, SAP
	Status Request	
SQ	Request Q Mode status	Unit sends "Q" Mode status string
SS	Request Front Panel status	Unit sends "S" Front Panel status string
ST	Request Channel status <i>Example:</i> '>ST'	Unit sends "T" Channel/Source status string Returns Channel/Source status response string
SV	Request AV status	Unit sends "V" Audio status string
	IP Setup	
IP=	IP Address	IP returns the current MAC address, current IP address, subnet mask, and gateway. Response example (S or D at end of IP signifies DHCP or Static address): \$MAC=0014C80313BF / 1 \$IP=192.168.001.231S IG=000.000.000.000 IM=255.255.255.000 IY=1 IP=xxx.xxx.xxx.xxx Defines IP address, then sends status (0.0.0.0 = DHCP)
IG=	IP Gateway	IG Returns current MAC address and IP information IG=xxx.xxx.xxx.xxx Defines IP gateway, then sends status
IM=	IP Subnet Mask	IM Returns current MAC address and IP information IM=xxx.xxx.xxx.xxx Defines IP subnet mask, then sends status
IY=	IP Mode	IY Returns current mode IY=1 Static (default) IY=2 DHCP
IX=	Telnet Port	IX Returns current Telnet port (00023 default) IX=xxxxx Defines Telnet port
U_	UPD Reply Port 31932	UO Turns UDP Reply port on

Code	Function	Operation
NW= NM=	Tuner Name	Sets name of tuner on Web page Set name: >NW=Tuner 1 Get name: >nm Reply: <1NMTuner1
M0=	LCD Backlight	0-9
M8=	LCD Contrast	0-8
R_	Refresh Rate	R6 = 59.94 Hz RM= 60 Hz

A carriage return is required at the end of each command and is assumed in all examples. The '=' sign for parameters may be omitted if desired, though it is helpful for clarity in checking programming.

Terminal Communication Commands

EF	Echo Off	Characters received will not be re-transmitted (power up default).
EN	Echo On	Characters received will be re-transmitted. <i>Example:</i> '>EN' Characters received will be re-transmitted.
ID	Product ID	Returns the product model number and firmware version.
Z!	Zap	Reconfigures unit for all factory default settings.

HD2-RC Remote Emulation

You can also emulate IR commands sent from the CR HD2-RC Wireless Remote.

KK=<key>	* = Reserved for future	May need Enter for channel entry
	0=* 1=* 2=* 3=* 4=* 5=* 6=* 7=* 8=* 9=Power (toggle)	88=Favorite 95=List 96=Add/Delete Channel 98=Air/Cable 99=Dash - 100=Info 101=Prev Chan 105=Menu 106=Cur Right 107=Cur Left 108=Cur Up
	10=0 11=1 12=2 13=3 14=4 15=5 16=6 17=7 18=8 19=9 20=	109=Cur Down 110=Enter/Select 111=Exit 115=CC 141=Format 1080i 142=Format 720p 143=Format 480p 144=Format 480i 145=Format 1080p 146=Format Auto 149=Output RGB (N/A)
	21=Enter/Select 22=Ch Up 23=Ch Dn 24=Vol Up 25=Vol Dn 26=Vol Mute (tog) 27=Power On 28=Power Off 29=Menu	151=Output YPbPr 153=Air 154=Cable 155=16:9 Ratio Pillar Box 4:3 Ratio Letterbox 156=16:9 Ratio Full Wide 4:3 Ratio Full 157=16:9 Ratio V Zoom 4:3 Ratio H Zoom
	63=Guide 80=Freeze 81=Signal 82=Ratio 85=Audio	158=AC-3(Dolby 5.1) 159=PCM 160=PCM Variable 161=Display 16:9 162=Display 4:3

Response Strings

Response Strings

Typical: [Attention] [Unit#] [data ...data] [cr] [lf]

232-ATSC-SDI 4 status response strings contain ASCII characters similar to those used for the same functions in command strings. An ASCII 'carriage return' and 'line feed' follow each response string. Functions shown as N/A are not applicable or available in the ATSC-SDI 4; characters will appear in status strings as lower-case x.

Channel/Source Status Response String (T):

Start	#	CMD	Power	Major Channel	Video Mute	Input	RF	Received Resolution	Minor Channel	NA	Function
	1-9		U=On M=Off	3 digits	Un-muted	0=RF	A=Air C=Cable	0=1080i 1=720p 2=480p 3=480i N=No Sig	3 digits		0=None
<	1	T	U	032	U	0	A	0	002	x	0

For compatibility with 232-series tuners, the 232-ATSC-SDI 4 channel status is split into Major Channel and Minor Channel sections. The Minor Channel will always be 000 for analog channels. The Minor Channel status will display "F00" if the Major channel is a special "one-part" digital channel. Also, as one-part channels can go higher than 999, the Minor status will tell you how many thousands (up to 63) you add to the Major number. So, channel 1032 would show 032 Major F01 Minor. Two-part channels are limited to 999-999.

Audio Status Response String (V):

Start	Unit	CMD	Power	Volume 1	Volume Mute	Stereo	Volume 2
	1-9		U=On M=Off	0-63 Emulated level 2 digits	U=Unmuted M=Mute	N/A	0-100 Actual level 3 digits
<	1	V	U	63	U	x	100

Volume 1 emulates 232-series volume level for compatibility with existing applications.

Volume 2 shows actual 232-ATSC-SDI 4 level, from 0-100 steps. Mute status will be sent if a user mutes volume from an IR remote.

Front Panel Mode Status Response String (S):

Start	Unit	CMD	Audio	Tune Mode	Lockout	Bass	Treble	Output	Output Resolution	Output Setting	NA
	1-9		N/A	0=Cable 1=Air 2=IRC 3=HRC 3=Auto	0-7	Fixed 2 digits	Fixed	0=RGB 2=YpPr	0=1080i 1=720p 2=480p 3=480i 4=1080p	0=1080i 1=720p 2=480p 3=480i 4=1080p 5=Auto	4 digits
<	1	S	x	1	0	08	4	2	0	0	xxxx

Current Ratio is the actual output ratio; Ratio Mode is the selected mode (see chart on page 9)

Q Mode Response String (Q):

Start	Unit	CMD	Q0	Q1	Q2	Q3	Q4	Q5	Q6	Q7	Q8	NA
	1-9		CC 0=Off 1=On	CC Type 1-8	Video Detect (fixed)	AV Detect (fixed)	Label (fixed)	IR 0=Off 9=Normal	1 digit	Digital CC 0=Off 1=On	Digital CC Services 1-6	2 digits
<	1	Q	1	1	3	0	2	9	0	1	1	xx

RS-232 Cable Connections

Single Tuner

Control Wiring – Single Unit

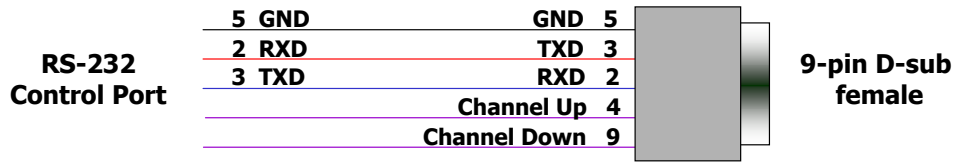

Contact closures on Pins 4 and 9 can be used with GND for channel up/down control.

Multiple Tuners

Up to nine tuners can be daisy-chained from one RS-232 control port. Remember that you will need to use the Unit# address in your programming when you control more than one tuner from the same control port.

Set the first unit in the RS-232 chain to the highest Unit#, then wire in sequence to the last tuner in the chain. The reason for this is that CR tuners use an intelligent data bus - the highest number tuner receives all commands, and then passes on commands addressed to tuners with lower unit numbers. The next tuner in the chain does the same, and so on until the last unit.

RS-232 Wiring – Two Units

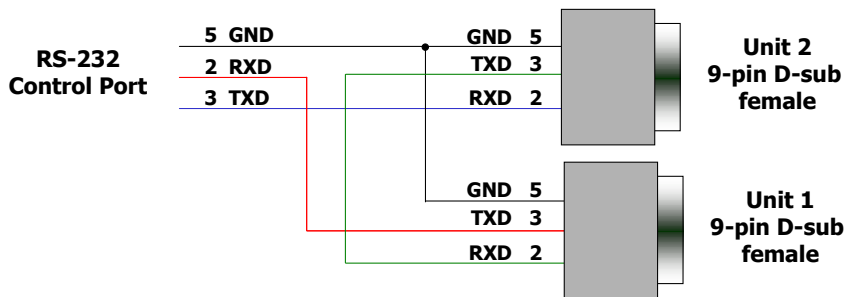

RS-232 Wiring – Three Units

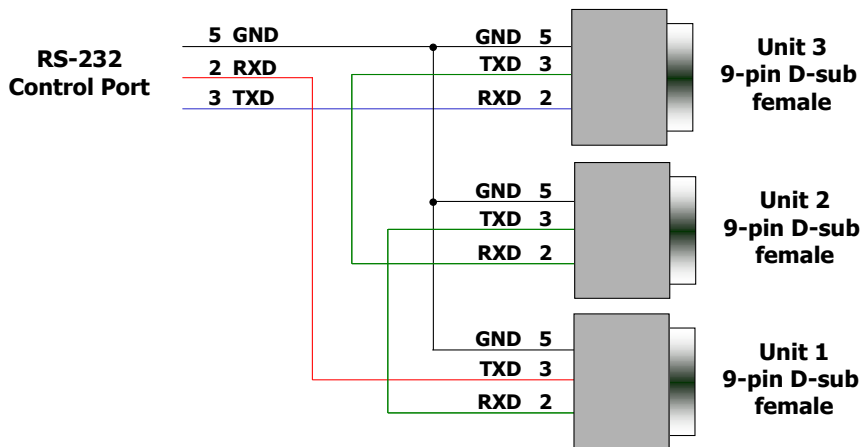

Specifications

Physical

Size (HWD): 8.5" [216mm] wide x 1.75" [44mm] height (1RU) x 8.0" [203mm] deep

Weight: 2.25 lbs [1 kg]

Enclosure: Steel with black powder coat paint

Mounting: 1RU Rack mounting for one or two units side-by-side (RK1, RK2EZ)
Use RK2EZ for mounting one tuner in a half-width rack

Cooling: Not required for normal applications, where there many tuners in one rack, a rack fan is recommended to add air flow

Front Panel



Display: Text Display, white text on blue LCD:

Top line indicates channel number and name

Lower line Input/Output resolution of current channel, and Air/Cable tuning

IR: IR sensor

Control: Power, Menu, Setup and Select buttons

Up and Down (Channel Up and Down) buttons

Left and Right (Volume Up and Down) buttons

Mini USB Port: for drag-and-drop firmware updates

Back Panel



Ethernet and Web page: RJ-45 10/100 Ethernet connector for Web pages and control

Supports 2 IP Telnet sessions, UDP control to port number of 31931, reply at 31932

Service: Use for memory stick firmware update for HD processor

Air/Cable: 'F', female, 75 ohm impedance

Supports dual Cable and Air tuning with optional RF-AB RF A-B Switch

Video Outputs: Simultaneous SDI, Component and NTSC video.

HD-SDI Out: 1080p@60Hz, 720p@59.94/60Hz, 1080i/480p@29.97Hz, or native channel resolution

Tuned program with embedded stereo AES or Dolby 5.1 audio, Dolby 5.1 selectable to pass through as AC-3 when audio set to AC-3 or decoded to stereo AES audio when set to PCM, select between Consumer or Pro digital audio

NTSC Video Out: RCA composite video output, 1V p-p at 75 ohm impedance, 480i

Component Out: 3 RCA Y, Pr, Pb outputs (1080p@60Hz, 720p@59.94/60Hz, 1080i/48p@29.97Hz or native

Audio Output: Simultaneous SDI, Coax, Optical, and Stereo, select between Consumer or Pro digital audio

Digital Audio SPDIF: Coax and Toslink optical output, Dolby 5.1 AC3/PCM/Variable PCM

Analog Audio Out: Stereo RCA audio, variable level

Control Options:

RJ-45: 10/100 Ethernet connector, Telnet control and onboard Web page. Supports 2 Telnet sessions, UDP control to port number of 31931, reply at 31932

RS-232: DB-9 male, RS-232 data link to control system (protocol is the same for RS-232 or Telnet)

300 to 19,200 baud (9600 default), 8 data bits, no parity, 1 stop bit

Control up to 9 tuners using daisy-chain wiring between ports

IR In: 3.5mm stereo jack for optional IR-RXC IR Receiver

Sleeve= DC power+ from power jack input, limited to less than 100mA

Ring=DC power- (GND)

Tip= IR data signal

Air/Cable (A/C): 3.5 mm output to operate the RF-AB RF A-B Switch

Power In: 2.1mm coaxial jack (inside center conductor positive)

1.1 A maximum, 11 to 14 VDC, 12 VDC typical

Tuning

Frequency Range: ATSC and Clear QAM (cable) television 55.25 to 801.25 MHz

TV System: ATSC, NTSC, Cable, and Clear QAM (1080i/720p/480p/480i)

Tuning: Off-air 2-69 (NTSC and 8-VSB) and CATV 1-135 (Analog, 64QAM, 256QAM, 8-VSB)

Aspect Ratio: 4:3, 16:9 (Digital), 4:3, 16:9, Zoom (Analog channels)

Captioning: DTV and analog, set by program or customized for size, font and display attributes

Lock: Parental option for channels and/or rating

Captioning

On-Screen: Displays on-screen analog and digital captioning on all video ports.

Captioning Data: SDI outputs 708 captioning for HD-SDI, 608 for 480i

(changing SDI output from native refresh rate may affect captioning data)

Component port doesn't have the ability to carry captioning data.

Captioning data from analog and digital channels will be expressed as Line 21 captioning on the composite video port.

Includes

HD2-RC IR Tuner Remote, 4 AAA batteries

Power Supply, 1.5A maximum, 12 VDC

Options

PS12-4Y 4A power supply with Y cable to drive 2-3 tuners (free at time of order)

RK1 Single Rack Kit, 1RU

RK2EZ Dual Rack Kit, 1RU

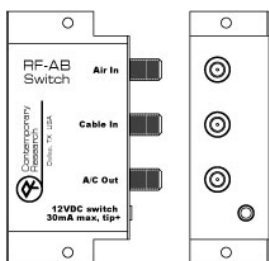

RF-AB RF A-B Switch, self-terminating, included 3,5mm cable connects to A/C DC output on tuner

IR-RXC External IR Receiver

CC-COM RS-232 Cable

Trademarks

- VGA and XGA are trademarks of International Business Machines
- SVGA is a trademark of the Video Electronics Standard Association
- HDMI, the HDMI logo and High-Definition Multimedia Interface are trademarks or registered trademarks of HDMI Licensing LLC.



Manufactured under license from Dolby Laboratories, Dolby and the double-D symbol are trademarks of Laboratories

Rack Mounting

Two options are available for rack-mounting ATSC Tuners, QMOD and units with similar enclosures.

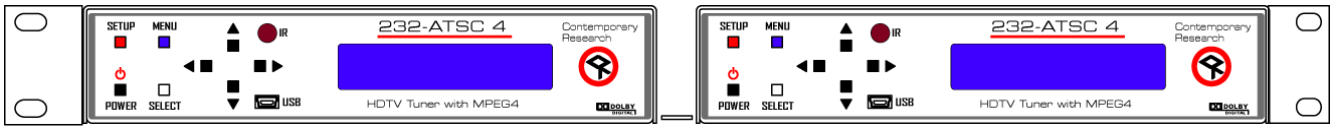

RK2EZ Dual Rack Kit with Tie Bar Mounting

New ATSC+1, ATSC+SDI, QMOD and QCA enclosures have a slot in the bottom middle of the case. This will accept a tie bar that will lock the two enclosures together without taking the cases apart

1. Check that your enclosures have the tie bar slot.
2. Slide the included tie bar into the side of one unit and attach with the included screws.
3. Slide the other unit into the tie bar, and attach the screws
4. Add the rack mounts to the sides.

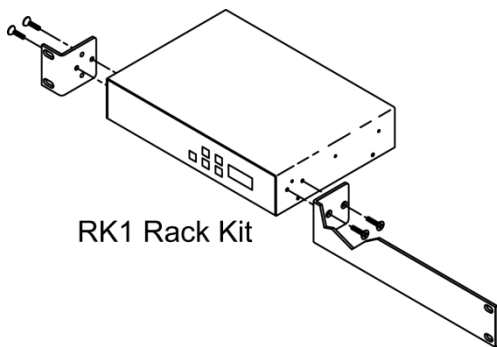

RK1 Single Unit Rack Mount

Attach the long and short rack ears to the side and towards the front of the unit with the four (4) supplied 8-32 by 1/4" (black) countersunk screws.

Limited Warranty and Disclaimer

Warranty: Three (3) year limited warranty on all parts and labor for Contemporary Research manufactured products from the day of purchase by authorized dealer. Manufactured products are warranted against defects in materials and workmanship. If Contemporary Research receives notice of such defects during the warranty period, Contemporary Research will repair or replace, at its option, products that prove to be defective.

Exclusions: The above warranty shall not apply to defects resulting from improper or inadequate maintenance by the customer, customers applied software or interfacing, unauthorized modifications or misuse, mishandling, operation outside the normal environmental specifications for the product, use of the incorrect, modified or extended power supply, or improper site operation and maintenance. *Please note Contemporary Research SSV-DX Display Express PC product carries a six month limited warranty.*

Safety Instructions

Read before operating equipment.

- **Cleaning** - Unplug this product from the wall outlet before cleaning. Do not use liquid cleaners or aerosol cleaners. Use a damp cloth for cleaning.
- **Power Sources** - Use supplied or equivalent UL/CSA approved low voltage DC plug-in transformer.
- **Outdoor Antenna Grounding** - If you connect an outside antenna or cable system to the product, be sure the antenna or cable system is grounded so as to provide some protection against voltage surges and built-up static charges. Section 810 of the National Electrical Code, ANSI/NFPA No. 70, provides information with respect to proper grounding of the mast and supporting structure, grounding of the lead-in wire to an antenna discharge unit, size of grounding conductors, location of antenna discharge unit, connection to grounding electrodes, and requirements for the grounding electrode.
- **Lightning** - Avoid installation or reconfiguration of wiring during lightning activity.

Power Lines - Do not locate an outside antenna system near overhead power lines or other electric light or power circuits or where it can fall into such power lines or circuits. When installing an outside antenna system, refrain from touching such power lines or circuits, as contact with them might be fatal.

- **Overloading** - Do not overload wall outlets and extension cords as this can result in a risk of fire or electric shock.
- **Object and Liquid Entry** - Never push objects of any kind into this product through openings as they may touch dangerous voltage points or short out parts, resulting in a fire or electric shock. Never spill liquid of any kind on the product.
- **Servicing** - Do not attempt to service this product yourself as opening or removing covers may expose you to dangerous voltage or other hazards. Refer all servicing to qualified service personnel.
- **Damage Requiring Service** - Unplug this product from the wall outlet and refer servicing to qualified service personnel under the following conditions:
 - When the power supply cord or plug is damaged.
 - If liquid spills or objects fall into the product.
 - If the product is exposed to rain or water.
 - If the product does not operate normally by following the operating instructions. Adjust only those controls that are covered by the operating instructions. An improper adjustment of other controls may result in damage and will often require extensive work by a qualified technician to restore the product to its normal operation.
 - If the video product is dropped or the cabinet is damaged.
 - When the video product exhibits a distinct change in performance, this indicates a need for service.

* Note to CATV system installer: This reminder is provided to call CATV system installer's attention to Article 820-40 of the National Electrical Code (Section 54 of Canadian Electrical Code, Part I), that provides guidelines for proper grounding and, in particular, specifies that the cable ground shall be connected to the grounding system of the building as close to the point of cable entry as possible.